

ORDER INFORMATION:

SDC038 - $\frac{XX}{a}$ D - $\frac{X}{b}$

- a. Pin of numbers:
09
- b. Pack selection:
D:Disk Pack
R:Reel Pack

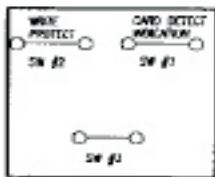
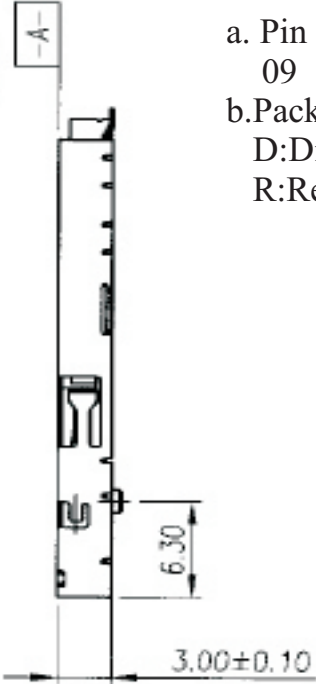
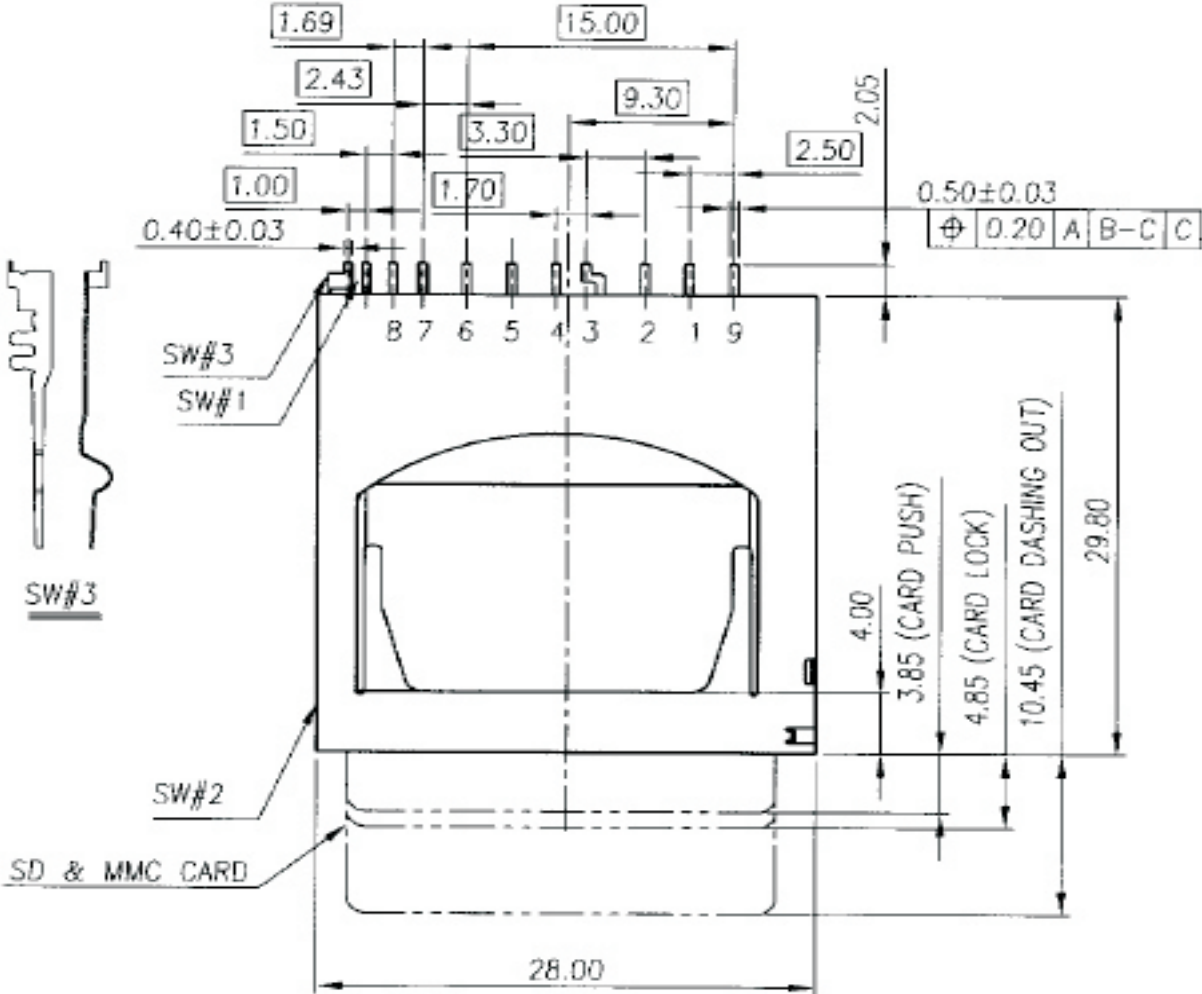

WITHOUT CARD

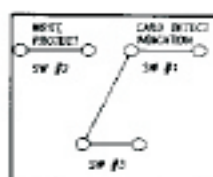

CARD INSERTED
WRITE PROTECT : LOCK

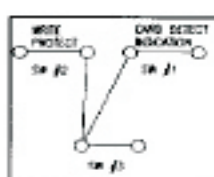

CARD INSERTED
WRITE PROTECT : UNLOCK

GENERAL TOLERANCE .X ± 0.30 .XX ± 0.20 .XXX ± 0.10	DRAW H. D. LI	PART NO SDC038-XXD-X
	DESIGN H. D. LI	TITLE SD MEMORY CARD PUSH-PUSH BIG SWITCH#3 CONNECTOR TYPE D
	CHECKED Y. M. LU	
	APPROVED J. F. KANG	
UNIT :mm		宏揚精密有限公司 HOJARI PRECISION CO., LTD.

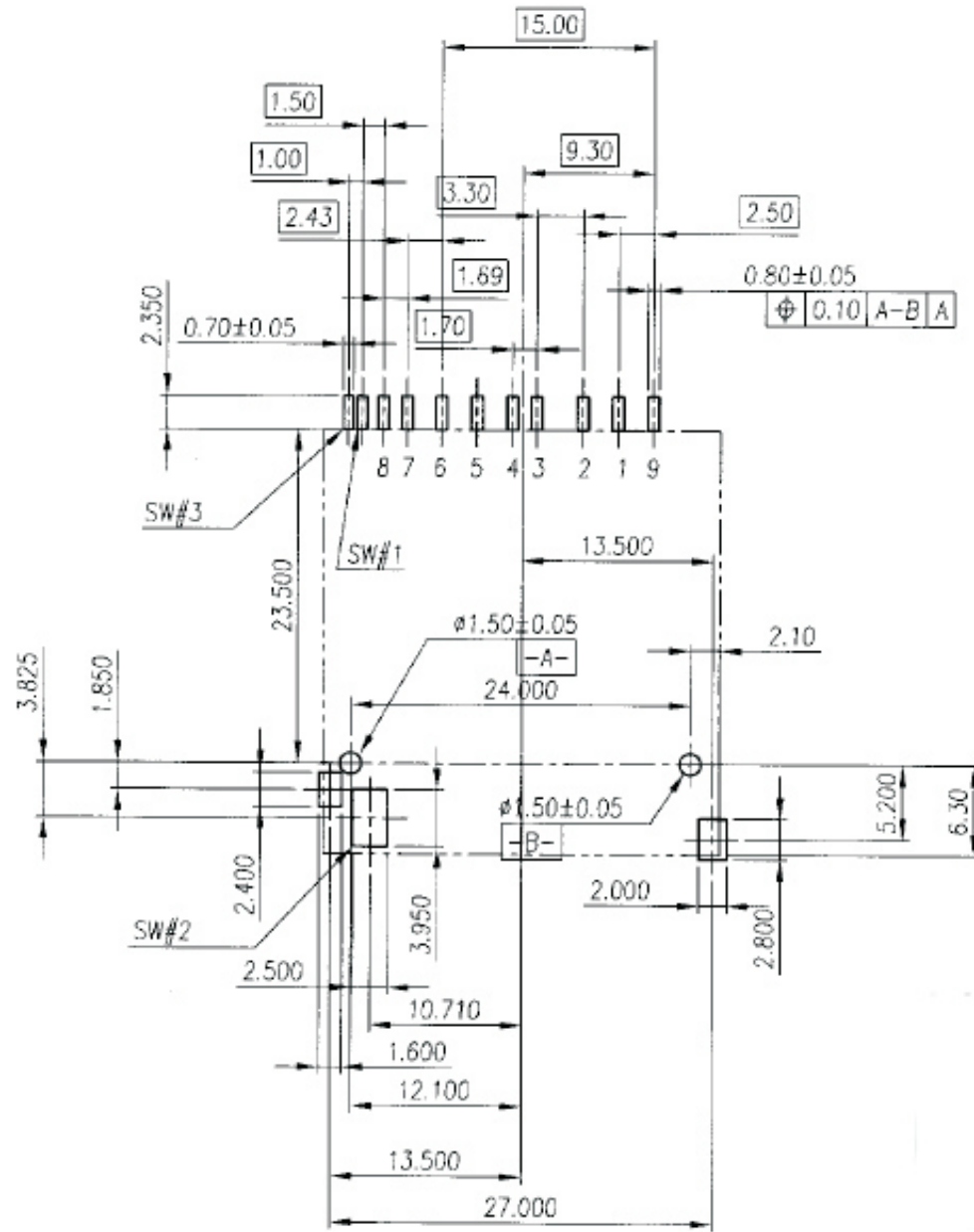

SD CARD PIN ASIGN	
PIN	NAME
1	CD/DAT3
2	CMD/D1
3	VSS1
4	VDD
5	CLK/SCLK
6	VSS2
7	DTA0
8	DTA1
9	DTA2

GENAL TOLERANCE .X ± 0.30 .XX ± 0.20 .XXX ± 0.10	DRAW	H. D. LI	PART NO SDC038-XXD-X
	DESIGN	H. D. LI	
	CHECKED	Y. M. LU	SD MEMORY CARD PUSH-PUSH BIG SWITCH#3 CONNECTOR TYPE D
	APPROVED	J. F. KANG	
UNIT :mm			 宏揚精密有限公司 HOJAR PRECISION CO., LTD.