

ORDER INFORMATION:

SIM254046 - $\frac{06}{a}$ C - BL - $\frac{X}{b}$

MATERIAL:

INSULATION: LCP (BLACK)

CONTACT: COPPER ALLOY

PLATING: SELECTED 30u" GOLD
OVER NICKEL 50u"

a. Pin number:

06

b. Pack :

R: Reel

GENERAL TOLERANCE .X ±0.30 .XX ±0.20 .XXX ±0.10	DRAW M. C. WA	PART NO SIM254046-06C-BL-X
	DESIGN M. C. WA	TITLE 簡易式 SIM CARD
	CHECKED Y. M. LU	
	APPROVED J. F. KANG	
UNIT :mm		 宏揚精密有限公司 HOJAR PRECISION CO., LTD.

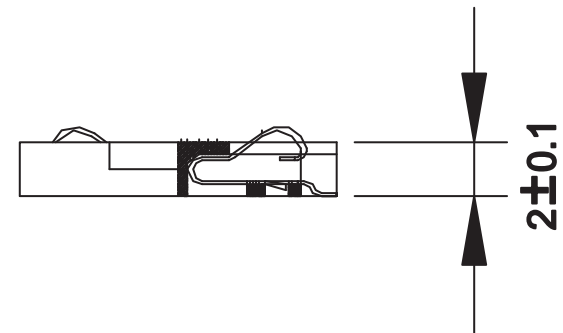
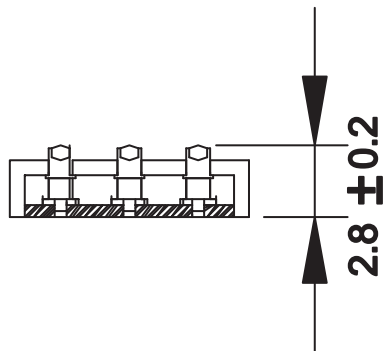
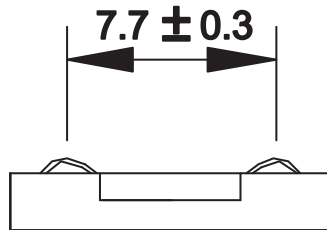
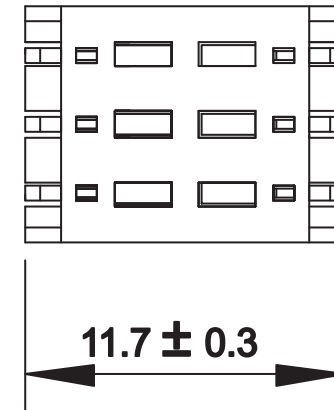
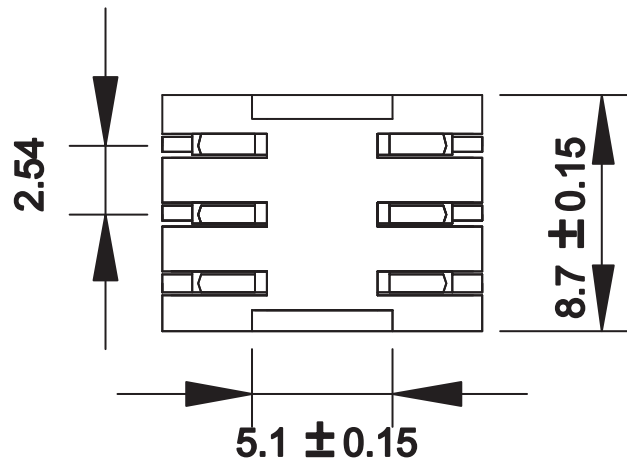
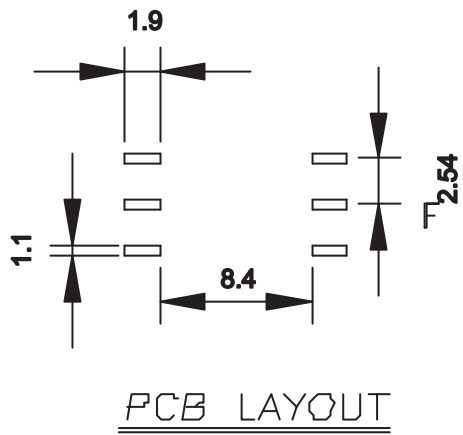

GENAL TOLERANCE .X ± 0.30 .XX ± 0.20 .XXX ± 0.10 UNIT :mm	DRAW	M. C. WA	PART NO	SIM254046-06C-BL-X
	DESIGN	M. C. WA	TITLE	簡易式 SIM CARD
	CHECKED	Y. M. LU	 宏揚精密有限公司 HOJAR PRECISION CO., LTD.	
	APPROVED	J. F. KANG		