

ORDER INFORMATION:

SFPCR10- $\frac{XXA3}{a}$ - L - L - $\frac{X}{b}$

NOTE :

- 1. Contacts Finish: Tin 100 "u" Over Nickel 50 "u"
- 2. Material: Insulator: Thermoplastic
Contacts: Phosphor Bronze

a. Pin of numbers:

04 ~ 35

b. Pack :

T : Tube

R: REEL (1500pcs/Reel)

GENAL TOLERANCE .X ± 0.2 .XX ± 0.15 .XXX ± 0.05	VER DRE. M. C. WANG	PART NO SFPCR10-XXA3-L-L-X
	DESIGN M. C. WANG	TITLE 1.0 ZIF FPC CONN. RIGHT ANGLE LOWER CONTACT TYPE.H:2.5mm
	CHECKED Y. M. LU	
UNIT :mm	APPROVED J. F. KANG	 宏揚精密有限公司 HOJAR PRECISION CO., LTD.

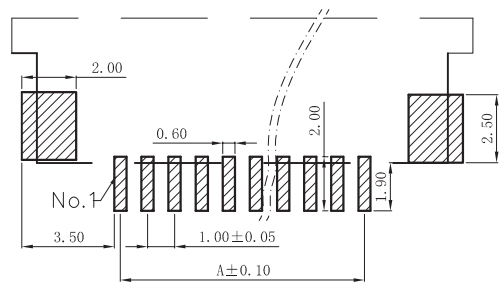
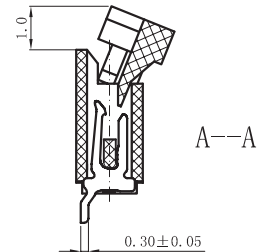
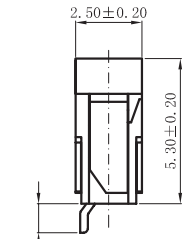
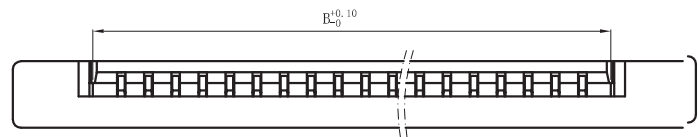
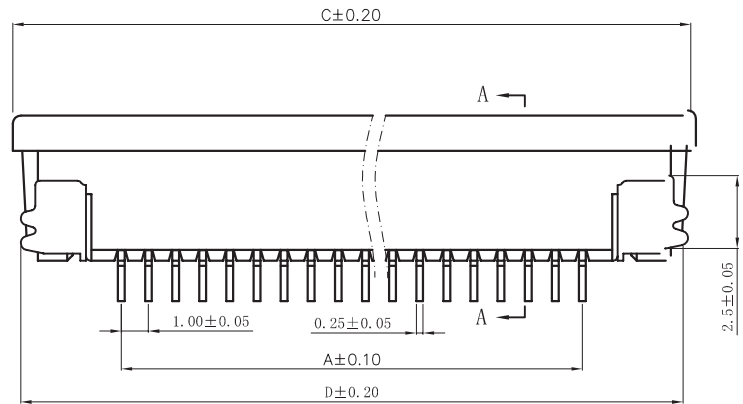

PCS Layout

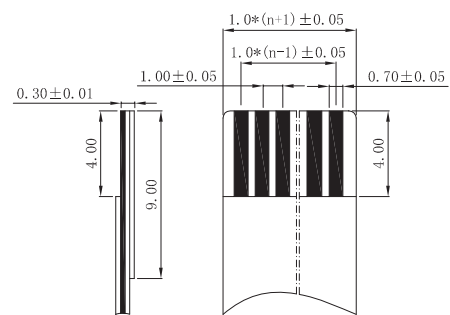

No. of Contacts	DIM. A	DIM. B	DIM. C	DIM. D
04	3	5.2	9.2	11
05	4	6.2	10.2	12
06	5	7.2	11.2	13
07	6	8.2	12.2	14
08	7	9.2	13.2	15
09	8	10.2	14.2	16
10	9	11.2	15.2	17
11	10	12.2	16.2	18
12	11	13.2	17.2	19
13	12	14.2	18.2	20
14	13	15.2	19.2	21
15	14	16.2	20.2	22
16	15	17.2	21.2	23
17	16	18.2	22.2	24
18	17	19.2	23.2	25
19	18	20.2	24.2	26
20	19	21.2	25.2	27
21	20	22.2	26.2	28
22	21	23.2	27.2	29
23	22	24.2	28.2	30
24	23	25.2	29.2	31
25	24	26.2	30.2	32
26	25	27.2	31.2	33
27	26	28.2	32.2	34
28	27	29.2	33.2	35
29	28	30.2	34.2	36
30	29	31.2	35.2	37
31	30	32.2	36.2	38
32	31	33.2	37.2	39
33	32	34.2	38.2	40
34	33	35.2	39.2	41
35	34	36.2	40.2	42

GENAL TOLERANCE .X ± 0.2 .XX ± 0.15 .XXX ± 0.05	VER DRE. M. C. WANG	PART NO SFPCR10-XXA3-L-L-X
	DESIGN M. C. WANG	TITLE 1.0 ZIF FPC CONN. RIGHT ANGLE LOWER CONTACT TYPE:H2.5mm
	CHECKED Y. M. LU	
UNIT :mm	APPROVED J. F. KANG	 宏揚精密有限公司 HOJAR PRECISION CO., LTD.