

Specifications

Electrical

Voltage Rating: 250V(AC)

Current Rating: 3A

Contact Resistance: 30mΩ Max.

Dielectric Withstanding Voltage: 600V AC/1min.

Insulation Resistance: 1000MΩ min.

Material

Insulator: PBT UL 94V-0

Color: Black

Contact: Brass 0.64mm(0.25") Square Wire Pins

Plating: Tin or Gold Plated

Temperature Range: -25°C~+105°C

Circuits: 4, 5

ORDER INFORMATION:

C R254 - XX $\frac{V}{a}$ - 1 - $\frac{X}{b}$

a. Pin of numbers:

03 ~ 05

b. Pack :

B : Bag

GENAL TOLERANCE .X ± 0.5 .XX ± 0.1	DRAW M. C. WANG	PART NO CR254-XXV-1-X
	DESIGN H. D. LI	TITLE 2.54mm Wire-to-Board Header For CD-ROM DIP 180度 TYPE WITH POST
	CHECKED Y. M. LU	
UNIT :mm	APPROVED J. F. KANG	 宏揚精密有限公司 HOJAR PRECISION CO., LTD.

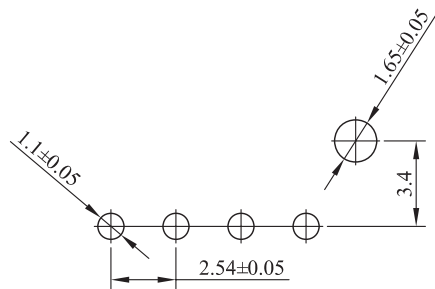
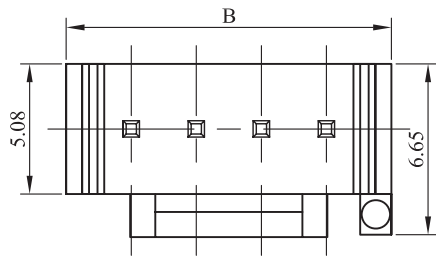

RECOMMENDED P.C. BOARD HOLE DIMM.

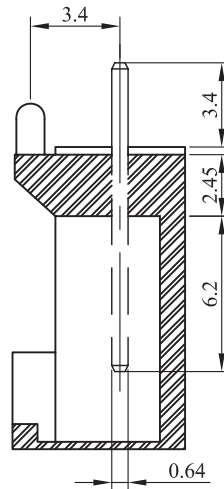
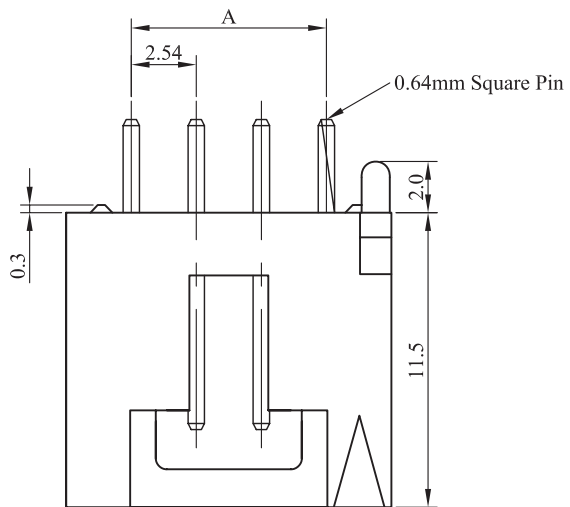

Poles	Dimension mm (in.)	
	A	B
3	5.08(0.200)	10.16(0.400)
4	7.62(0.300)	12.70(0.500)
5	10.16(0.400)	15.24(0.600)

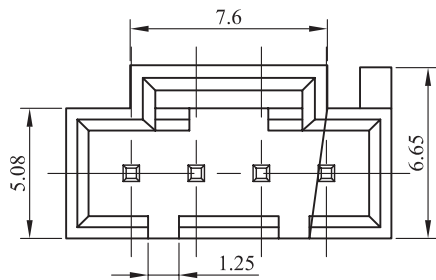

GENAL TOLERANCE .X ± 0.5 .XX ± 0.1	DRAW M. C. WANG	PART NO CR254-XXV-1-X
	DESIGN H. D. LI	TITLE 2.54mm Wire-to-Board Header For CD-ROM DIP 180度 TYPE WITH POST
	CHECKED Y. M. LU	
UNIT :mm	APPROVED J. F. KANG	 宏揚精密有限公司 HOJAR PRECISION CO., LTD.