

SPECIFICATIONS

Current Rate: 5 Amps

Insulator Resistance : 5000M Ω Min at 500V DC

Dielectric Strength : 1000V Per minute

Operation Temperature : -55°C ~ +105°C

MATERIAL

Insulator : P.B.T +30% Glass Fiber (UL94V-0)

Contact : Brass

Contact Plated : Gold

Shell : Steel, Nickle plated

ORDER INFORMATION:

MDSUB - 25 3 - $\frac{X}{a}$

a. Pack :

D : Disk Pack

VERSION & EC DESCRIPTION

DATE	VERSION	PAGE	DESCRIPTION
2005/02/25	A	22-23	Add MDSUB - 25 3 - X Plan

GENAL TOLERANCE	DRAW DATE	2005/02/25 H. D. LI	PART NO
.X \pm 0.5	DESIGN	H. D. LI	MDSUB - 25 3 - X
.XX \pm 0.30	CHECKED	Y. M. LU	TITLE
.XXX \pm X.XX	APPROVED	J. F. KANG	D-SUB Male 25Pin 卯附半金
UNIT :mm			 宏揚精密有限公司 HOJAR PRECISION CO. : LTD.

VERSION

A

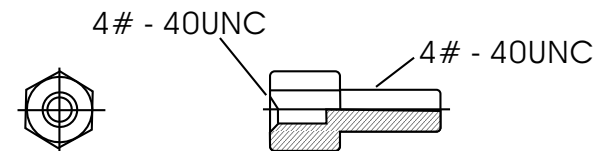
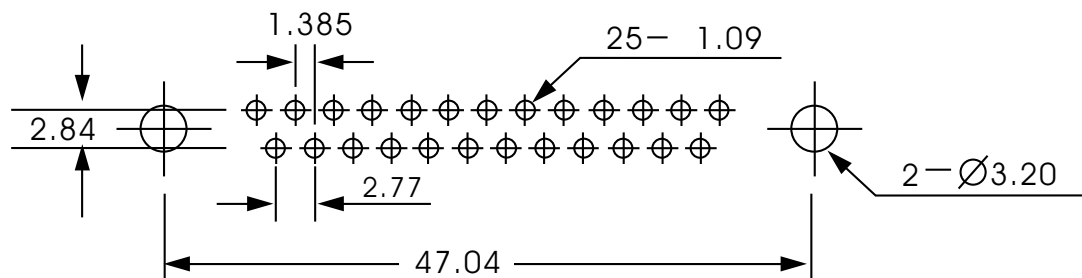
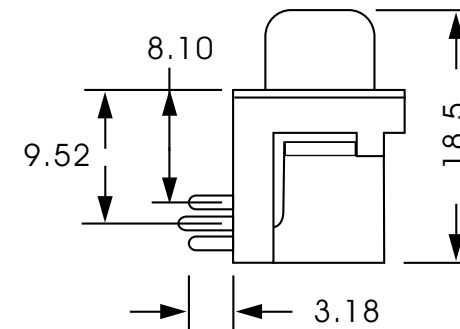
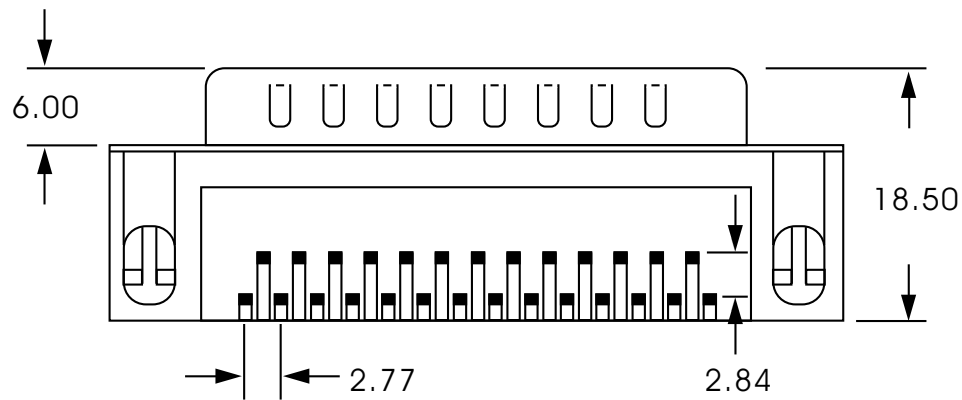
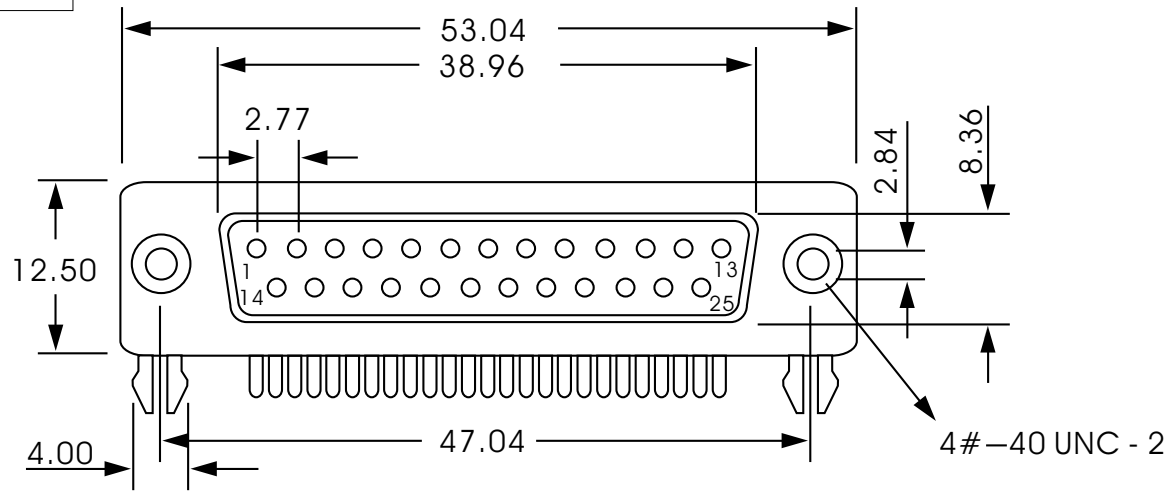

P.C.B LAYOUT

GENERAL TOLERANCE .X ± 0.5 .XX ± 0.30 .XXX ± X.XX	DRAW DATE	2005/02/25 H. D. LI	PART NO
	DESIGN	H. D. LI	MDSUB - 25 3 - X
	CHECKED	Y. M. LU	TITLE
	APPROVED	J. F. KANG	D-SUB Male 25Pin 卯附半金
UNIT :mm			 宏揚精密有限公司 HOJAR PRECISION CO. : LTD.