

ORDER INFORMATION:

DHMINID066 - $\frac{05}{a}$ V - $\frac{B}{b}$ $\frac{P}{c}$ - $\frac{D}{d}$

- a. Position:
05
- b. Color selection:
B:Black
- c. Insulator material:
P:PBT
- d. Pack selection:
D:Disk Pack

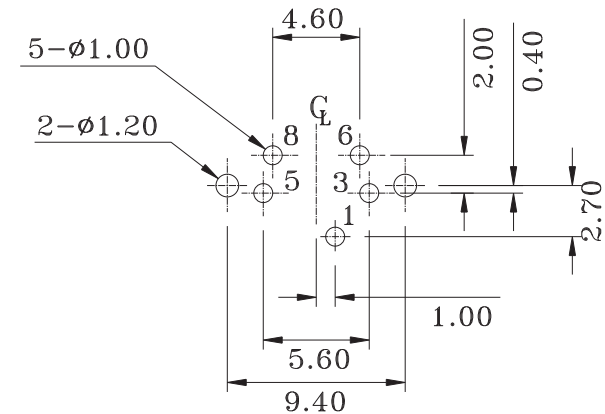
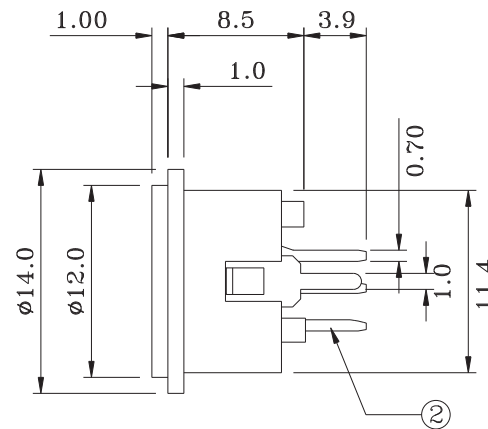
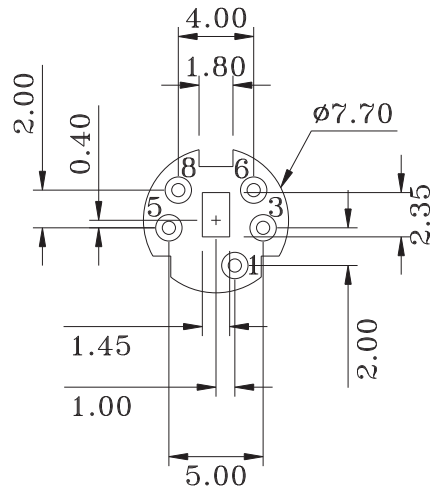
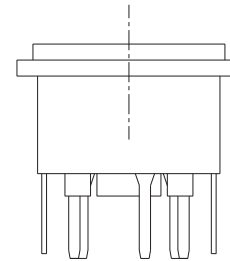
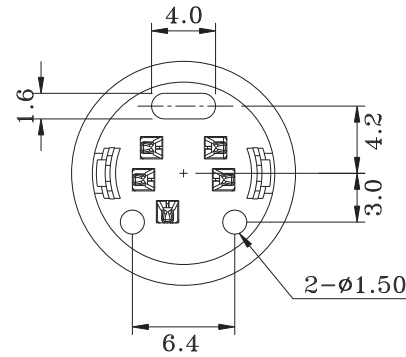
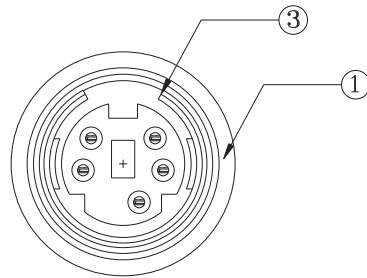

COMPONENT SIDE
(PCB LAYOUT)

NO.	NAME	MATERIAL	FINISH	Q'TY	REMARK
1	HOUSING	P.B.T.	BLACK	1	
2	CONTACT TERM.	PHOS. BRONZE T:0.2	SILVER PLATED	5	Ag:20~30 μ"
3	GROUND TERM.	BRASS T:0.3	TIN PLATED	1	Sn:120~200 μ"

GENAL TOLERANCE ± 0.30	DATE H. D. LI	PART NO DHMINID066-05V-BP-D
	DESIGN H. D. LI	TITLE MINI DIN JACK 5P VERTICAL
	CHECKED Y. M. LU	
UNIT :mm	APPROVED J. F. KANG	 宏揚精密有限公司 HOJAR PRECISION CO., LTD.