

ORDER INFORMATION:

DHMINID066 - 6 08 - B P - D
 a b c d e

- a. Shell option:
6:FULLY SHIELDED & SPRING WITH STRAIGHT TABS
- b. Position:
08
- c. Color selection:
B:Black
- d. Insulator material:
P:PBT
- e. Pack selection:
D:Disk Pack

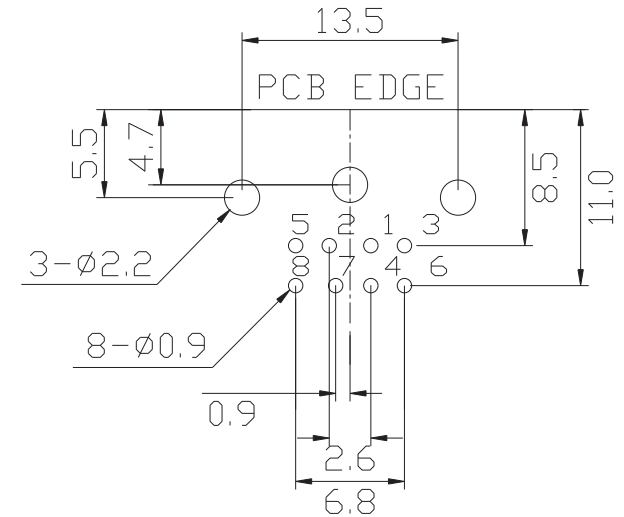
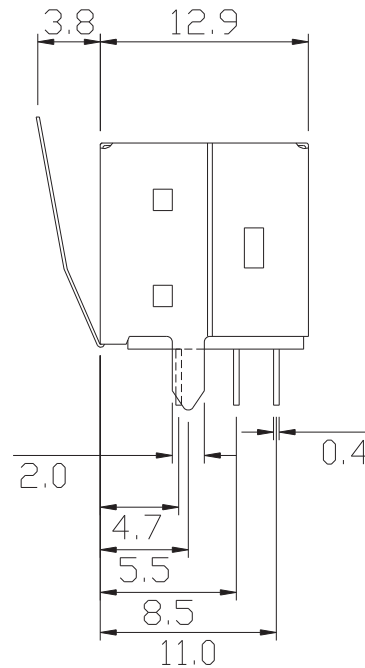
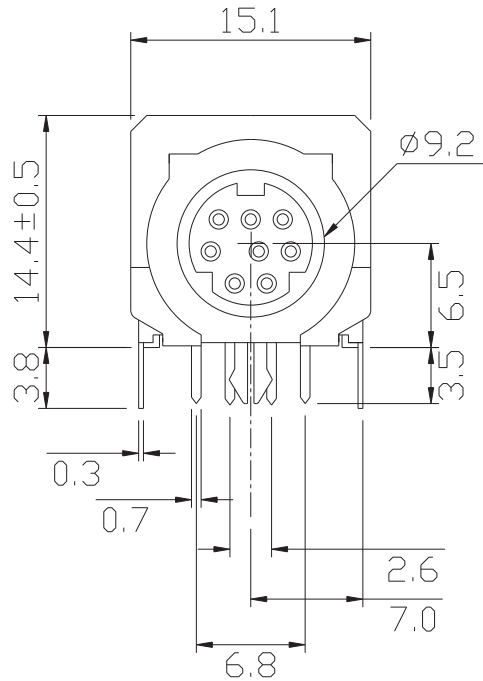
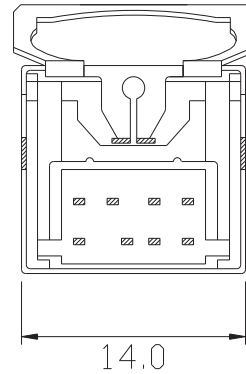
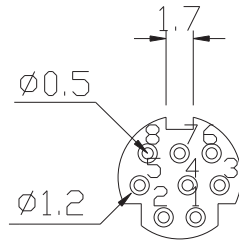

PCB LAYOUT
(BOTTOM VIEW)

NO.	NAME	MATERIAL	FINISH	Q'TY	REMARK
1	HOUSING	PBT G.F.	BLACK	1	
2	CONTACT	PHOS. BRONZE T:0.2	GOLD-TIN PLATED	8	Gold:1~3u"; NI:40~60u"; TIN:120u" (100% pure Tin of lead free plating)
3	SHIELD	BRASS T:0.3	TIN PLATED	1	TIN:120~200u"
4	BOTTOM COVER	PBT G.F.	BLACK	1	
5	SPRING SHIELD	STAINLESS T:0.2		1	

GENERAL TOLERANCE ± 0.30	DATE	H. D. LI	PART NO DHMINID066-608-BP-D
	DESIGN	H. D. LI	
	CHECKED	Y. M. LU	TITLE MINI DIN JACK 8P RIGHTANGLE WITH FULLY SHIELDED & SPRING TYPE
	APPROVED	J. F. KANG	 宏揚精密有限公司 HOJAR PRECISION CO., LTD.
UNIT :mm			