

ORDER INFORMATION:

SEAR13- 053X -X - A/B/C - X
 a b c d

a. SCHEMATIC:

A

b. Post selection:

1: with post

c. Length/Width/Height:

A/B/C (A=15.2,B=9.5,C=5.0) (standard)

d. Pack selection:

R:Reel Pack

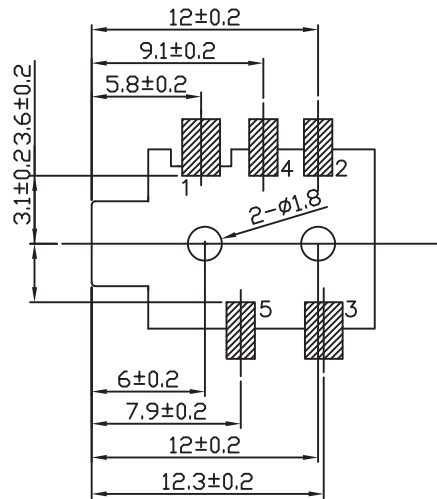

T:1.6 Dimensions of PC board holes
 Tolerance : ±0.1(Printed-top view)

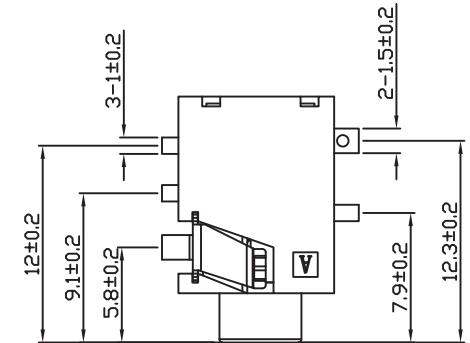
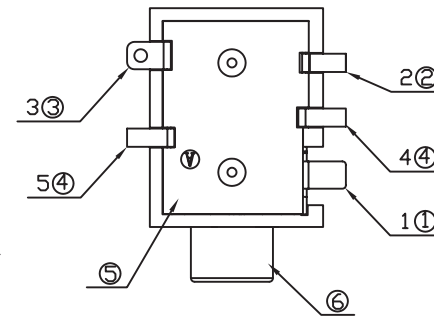
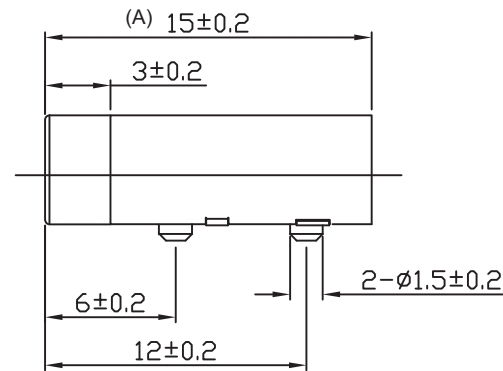
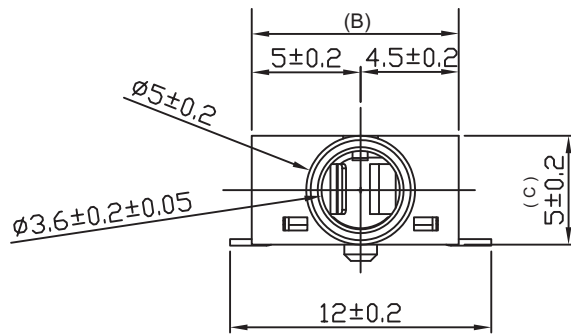
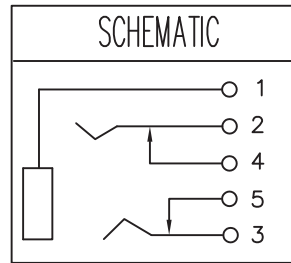
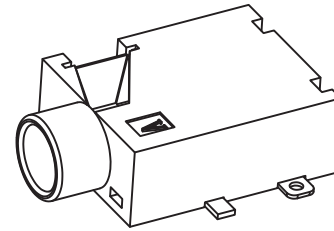

6	HOUSING PJ-3518	1	PA (BLACK)	
5	COVER PJ-3518	1	PA (BLACK)	
4	TERMINAL PJ-3518-4#	2	BRASS t=0.30	Au-Plated
3	TERMINAL PJ-3518-3#	1	PHOSPHOR BRONZE t=0.20	Au-Plated
2	TERMINAL PJ-3518-2#	1	PHOSPHOR BRONZE t=0.20	Au-Plated
1	TERMINAL PJ-3518-1#	1	PHOSPHOR BRONZE t=0.30	Au-Plated
LTR	PART NAME	QTY	MATERIAL	REMARK

GENAL TOLERANCE ± 0.2	DRAW M. C. WANG	PART NO SEAR13-053X-X-A/B/C-X
	DESIGN H. D. LI	TITLE 3.5mm MINIATURE JACK (SMT)
	CHECKED Y. M. LU	
UNIT :mm	APPROVED J. F. KANG	宏揚精密有限公司 HOJAR PRECISION CO., LTD.