

ORDER INFORMATION:

SEAR13-072X-X-A/B/C-X
 $\frac{a}{b} \frac{c}{d}$

a. SCHEMATIC:

A

b. Post selection:

1: with post

c. Length/Width/Height:

A/B/C (A=14.0,B=6.0,C=5.5) (standard)

d. Pack selection:

R:Reel Pack

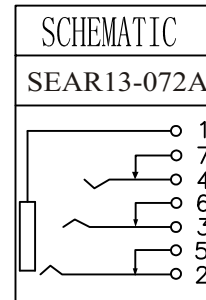
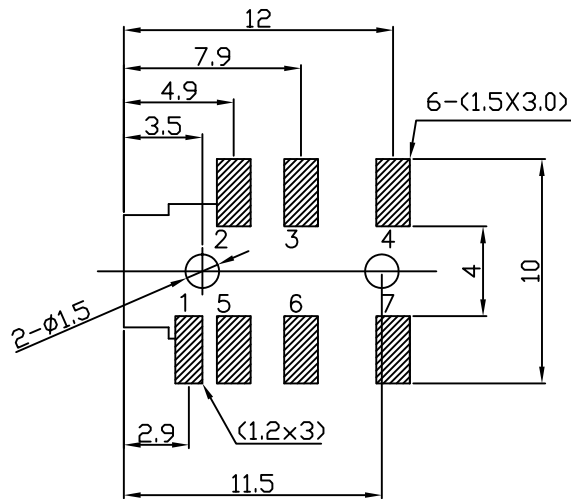
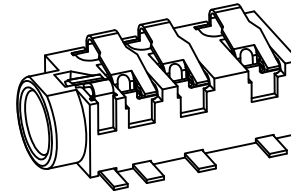

T:1.6 Dimensions of PC board holes

Tolerance : ± 0.1 (Printed-top view)

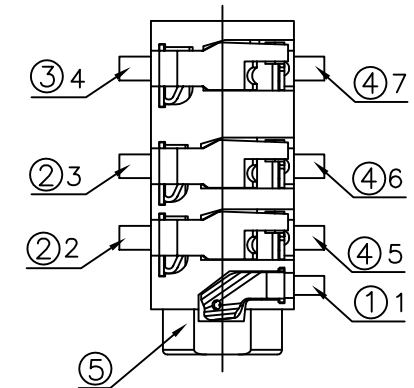
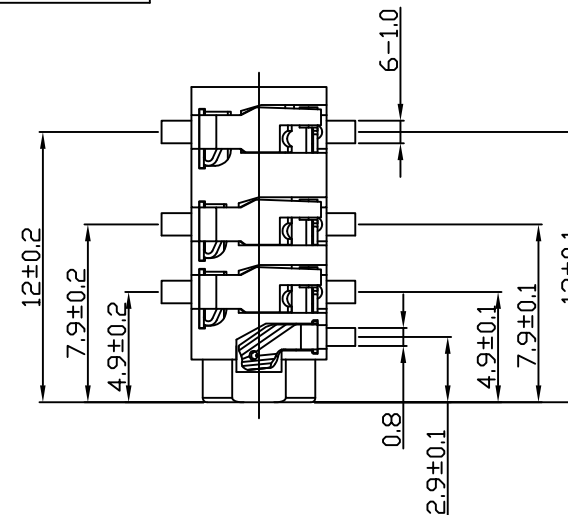
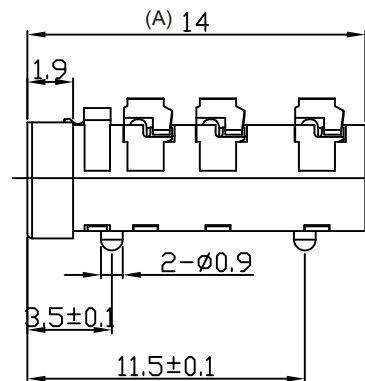
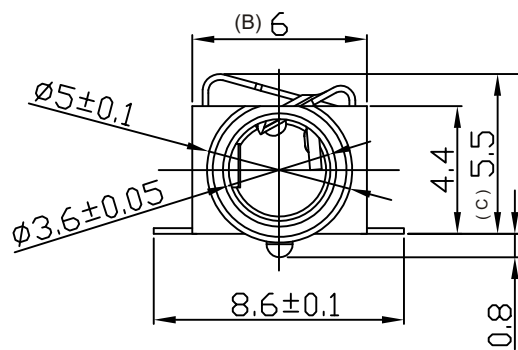

5	HOUSING	1	FR52	
4	4#CONTACT FOOT	1	BRASS	MB:Cu Au PLATED
3	3#CONTACT FOOT	1	PHOSPHOR BRONZE	MB:Cu Au PLATED
2	2#CONTACT FOOT	1	PHOSPHOR BRONZE	MB:Cu Au PLATED
1	1#CONTACT FOOT	1	PHOSPHOR BRONZE	MB:Cu Au PLATED
LTR	PART NAME	QTY	MATERIAL	REMARK

GENAL TOLERANCE ± 0.2	DRAW M. C. WANG	PART NO SEAR13-072X-X-A/B/C-X
	DESIGN H. D. LI	TITLE 3.5mm MINIATURE JACK (SMT)
	CHECKED Y. M. LU	
UNIT :mm	APPROVED J. F. KANG	宏揚精密有限公司 HOJAR PRECISION CO., LTD.